

MERABO

free time on the move

MERAK

IT	Istruzioni di montaggio	LV	Pritvirtinimo instrukcijas
EN	Fitting instructions	NL	Instrukcja montażu
DE	Montageanleitung	NO	Monteringsveiledning
FR	Instructions de montage	PL	Instrukcja montażu
ES	Instrucciones de montaje	PT	Instruções de Montagem
CS	Návod na montáž	RO	Instrucțiuni de montare
DA	Monteringsvejledning	RU	Инструкции по установке
EL	Οδηγίες συναρμολόγησης	SK	Návod na montáž
ET	Paigaldusjuhend	SL	Navodila za pritrjevanje
FI	Asennusohje	SV	Monteringsanvisning
HR	Uputa za sastavljanje	TK	Uydurma talimat
HU	A felszerelés módja	ZH	裝修指導
LT	Stiprināšanas instrukcija	AR	تعليمات التجميع

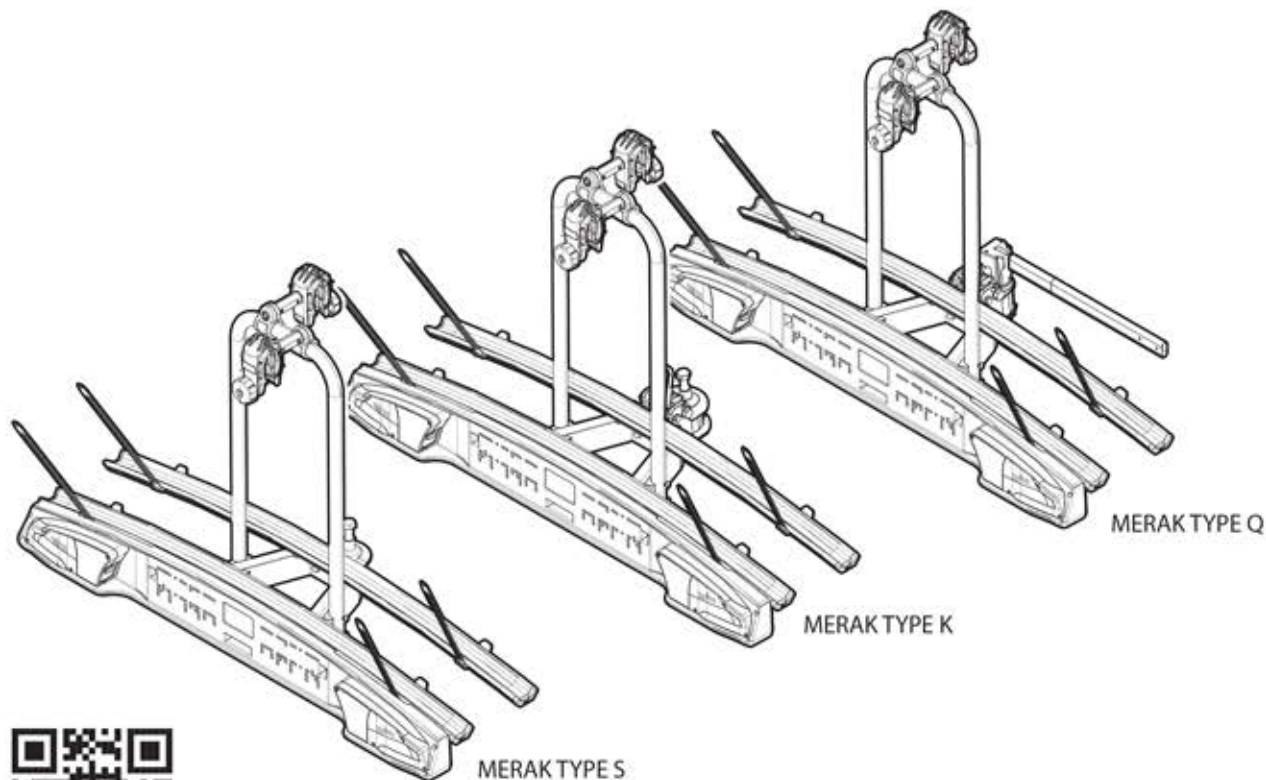

Made in Italy









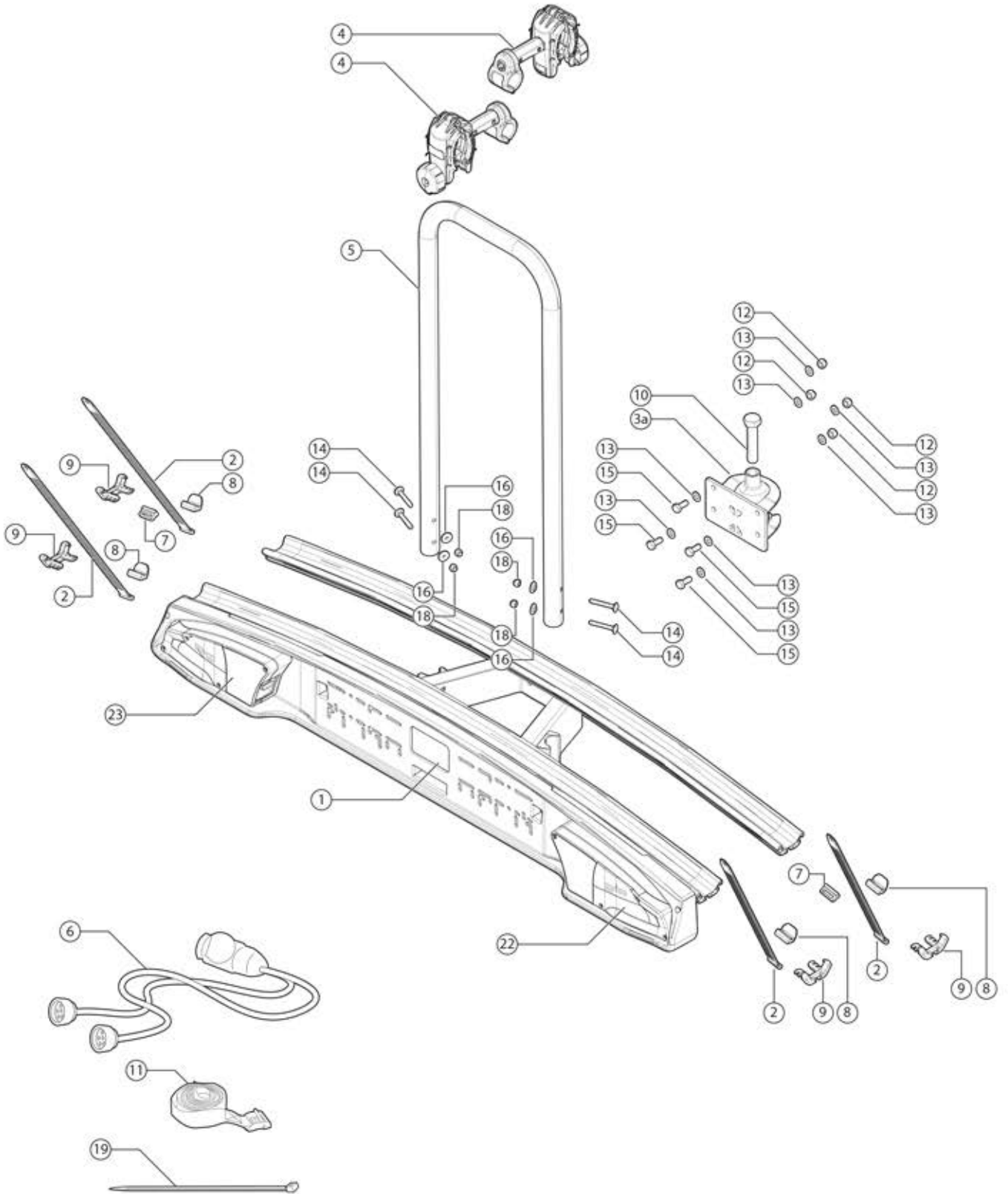











MERAK TYPE S



















N.	(IT)Componenti (Inclusi) (EN)Components (Included) (FR)Composants (Compris) (DE)Die Komponenten (im Lieferumfang enthalten) (ES)Componentes (Incluido)	Q.
1		1
2		4
3a		1
4		2
5		1
6		1
7		2
8		4
9		4
10		1
11		1
12		4
13		8
14		4
15		4
16		4
18		4
19		2

N.	(IT)Ricambi (A Richiesta) (EN)Spare Parts (Made to order) (FR)Pièces de rechange (Sur commande) (DE)Teile (auf Anfrage) (ES)Piezas de recambio (Previa solicitud)	Q.	Codice-Código
2		1	700003800000
7		2	
8		1	
3a		1	700003000000
4		1	700003200000
22		1	700033700000
23		1	700033800000
6		1	700033600000
9		2	700003900000
10		1	700004100000
11		1	700001100000
12		4	700037000000
13		8	
14		4	
15		4	
16		4	
18		4	

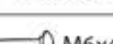

MERAK TYPE K

N.	(IT)Componenti (Inclusi) (EN)Components (Included) (FR)Composants (Compris) (DE)Die Komponenten (im Lieferumfang enthalten) (ES)Componentes (Incluido)	Q.
1		1
2		4
3b		1
4		2
5		1
6		1
7		2
8		4
9		4
10	 M16x70	1
11	 2,5m / 8ft	1
12	 M8	4
13	 Ø8x17	4
14	 M6x45	4
15	 M8x20	4
16		4
17		1
18	 M6	4
19		2

N.	(IT)Ricambi (A Richiesta) (EN)Spare Parts (Made to order) (FR)Pièces de rechange (Sur commande) (DE)Teile (auf Anfrage) (ES)Piezas de recambio (Previa solicitud)	Q.	Code - Code - Código
2		1	700003800000
7		2	
8		1	
3b		1	700011500000
17		1	
4		1	700003200000
22	 DX	1	700033700000
23	 SX	1	700033800000
6		1	700033600000
9		1	700003900000
10	 M16x70	1	700004100000
11	 2,5m / 8ft	1	700001100000
12	 M8	4	700037000000
13	 Ø8x17	8	
14	 M6x45	4	
15	 M8x20	4	
16		4	
18	 M6	4	
17		1	

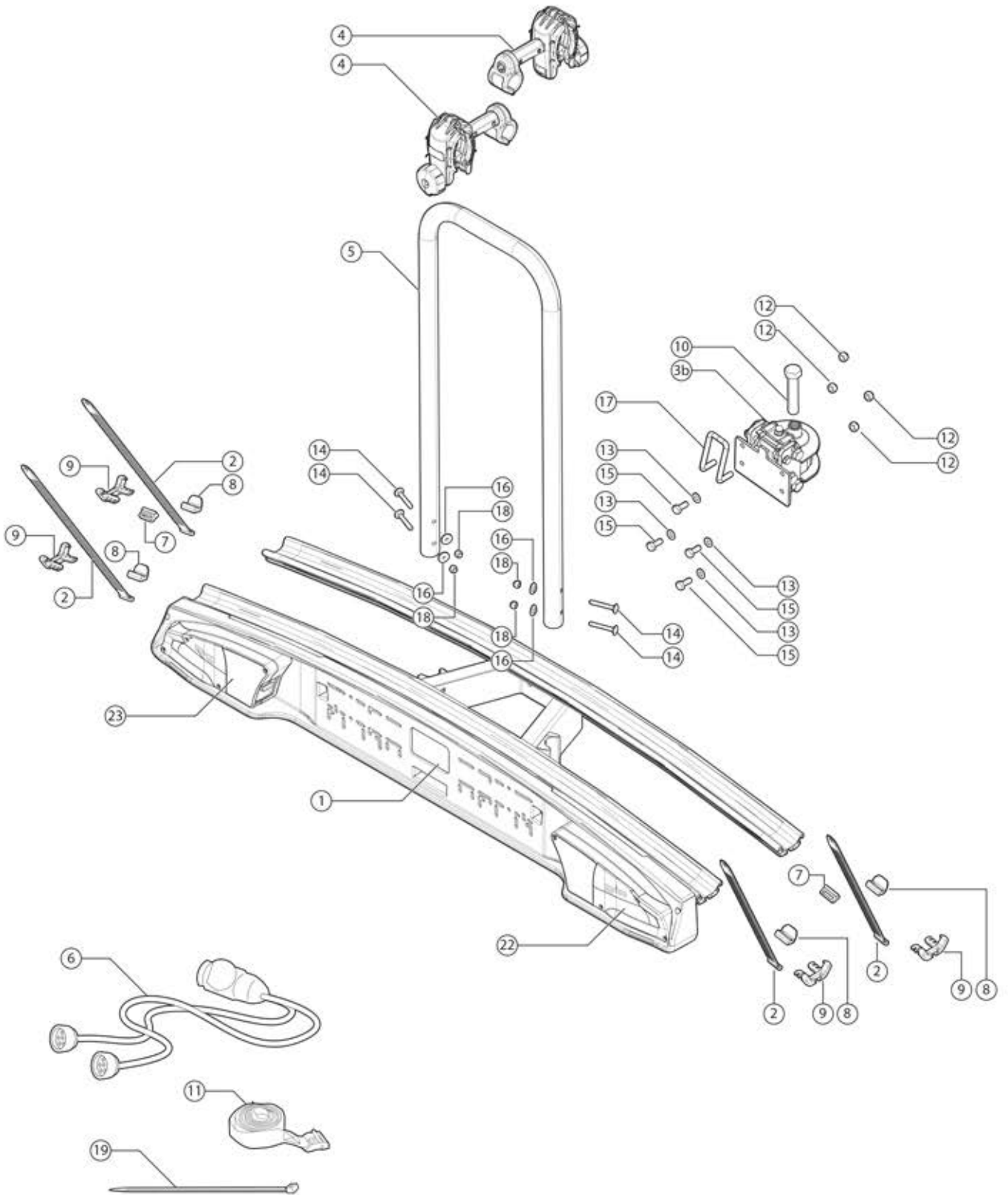



MERAK TYPE Q

N.	(IT)Componenti (Inclusi) (EN)Components (Included) (FR)Composants (Compris) (DE)Die Komponenten (im Lieferumfang enthalten) (ES)Componentes (Incluido)	Q.
1		1
2		4
3c		1
4		2
5		1
6		1
7		2
8		4
9		4
11	2,5m / 8ft	1
12	M8	4
13	Ø8x17	4
14	M6x45	4
15	M8x20	4
16		4
17		1
18	M6	4
19		2
20		1
21	4mm/0.1"	1

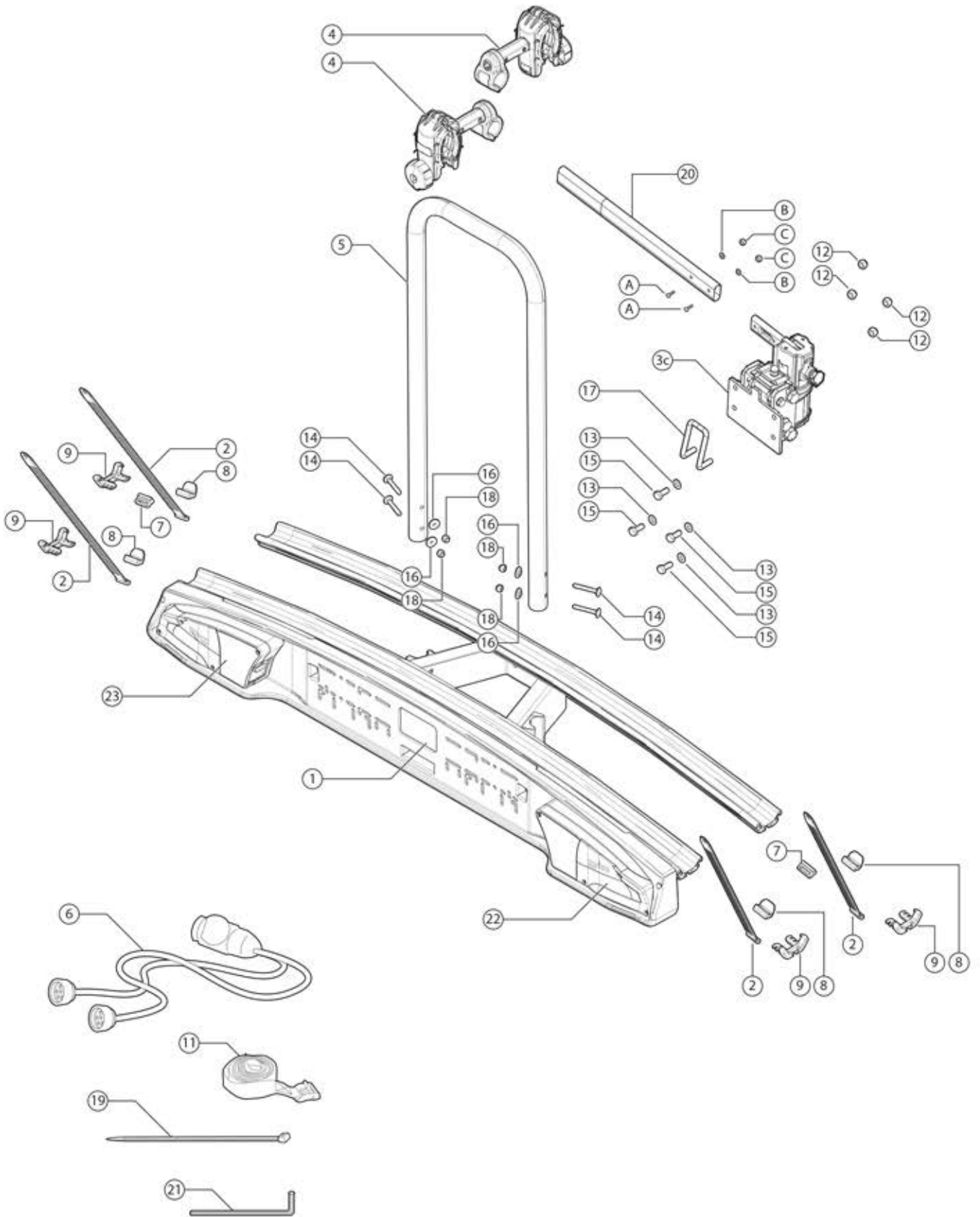
N.	(IT)Ricambi (A Richiesta) (EN)Spare Parts (Made to order) (FR)Pièces de rechange (Sur commande) (DE)Teile (auf Anfrage) (ES)Piezas de recambio (Previa solicitud)	Q.	Codice-Código
2		1	700003800000
7		2	
8		1	
3c		1	700011400000
17		1	
20		1	
21	4mm/0.1"	1	
4		1	700003200000
22	DX	1	700033700000
23	SX	1	700033800000
6		1	700033600000
9		1	700003900000
11	2,5m / 8ft	1	700001100000
12	M8	4	700037000000
13	Ø8x17	8	
14	M6x45	4	
15	M8x20	4	
16		4	
18	M6	4	
17		1	
17		1	700004300000



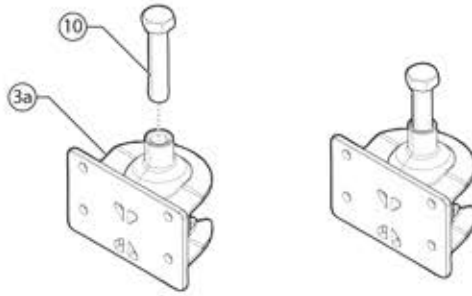

TYPES

N.		Q.
3a		1
10	 M16x70	1







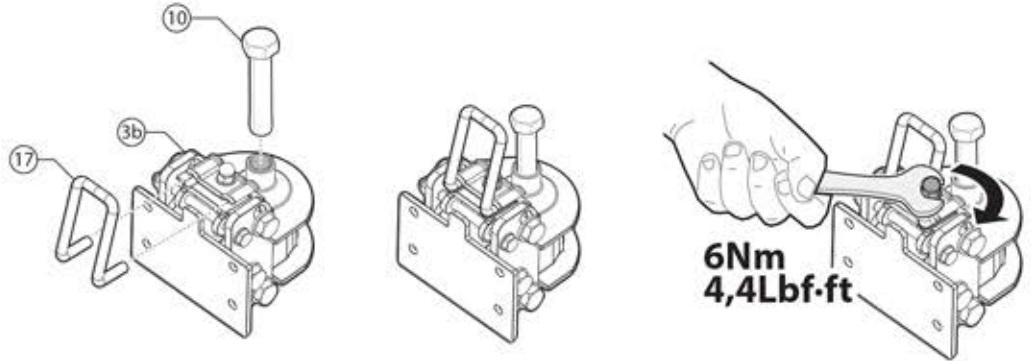

TYPE K

N.		Q.
3b		1
10	 M16x70	1
17		1





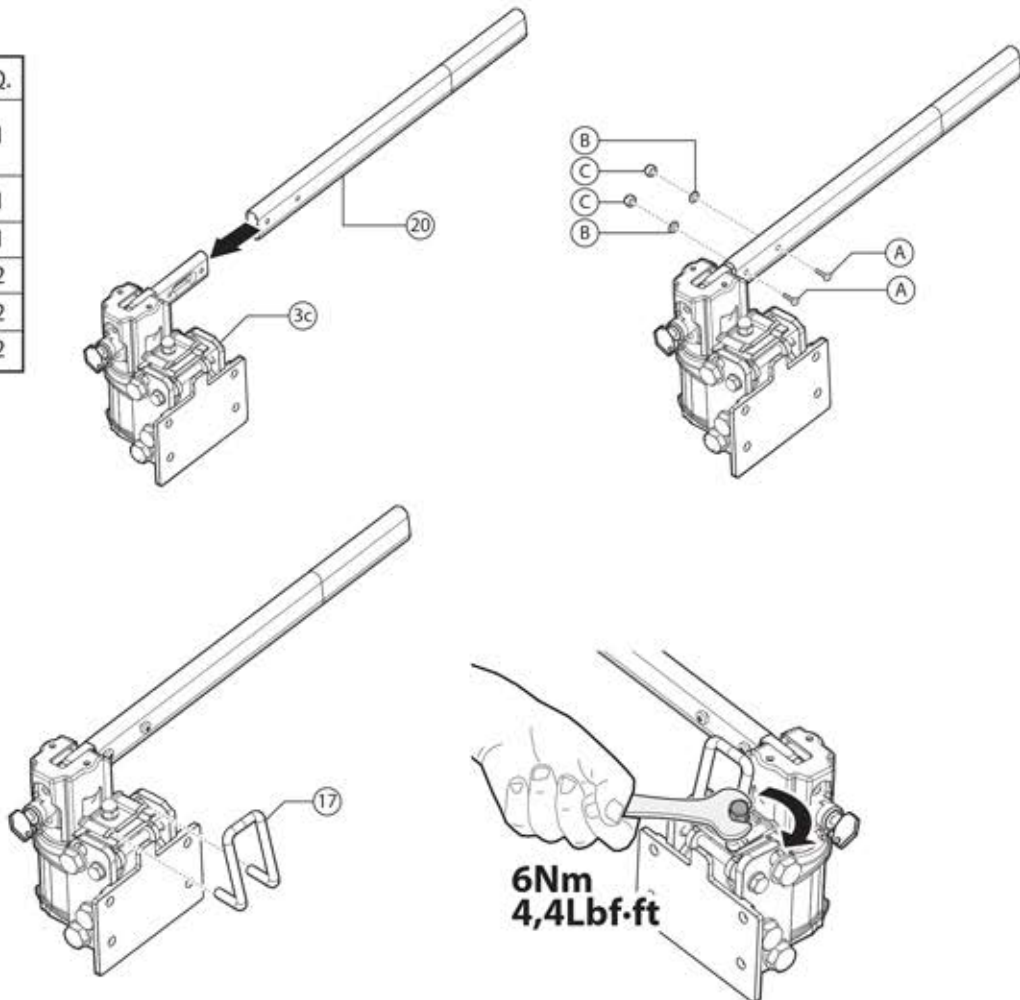

TYPE Q

N.		Q.
3c		1
17		1
20		1
A		2
B		2
C		2





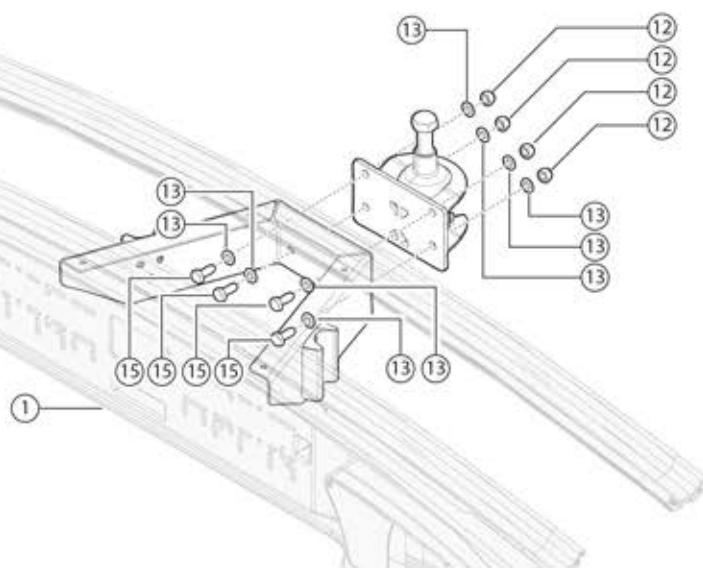

TYPE S

N.		Q.
1		1
12	 M8	4
13	 Ø8x17	8
15	 M8x20	4



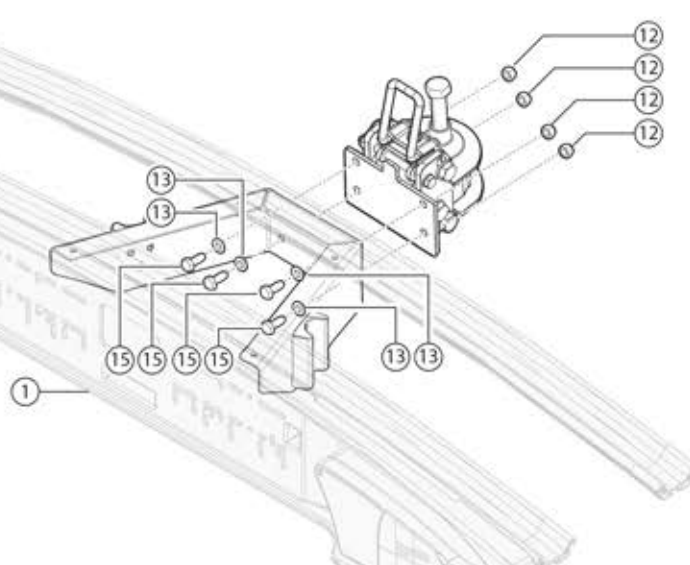

TYPE K

N.		Q.
1		1
12	 M8	4
13	 Ø8x17	4
15	 M8x20	4





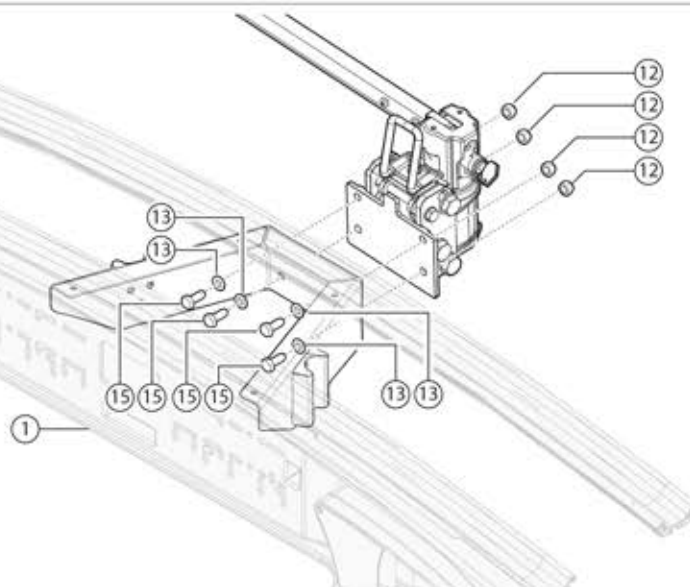

TYPE Q

N.		Q.
1		1
12	 M8	4
13	 Ø8x17	4
15	 M8x20	4



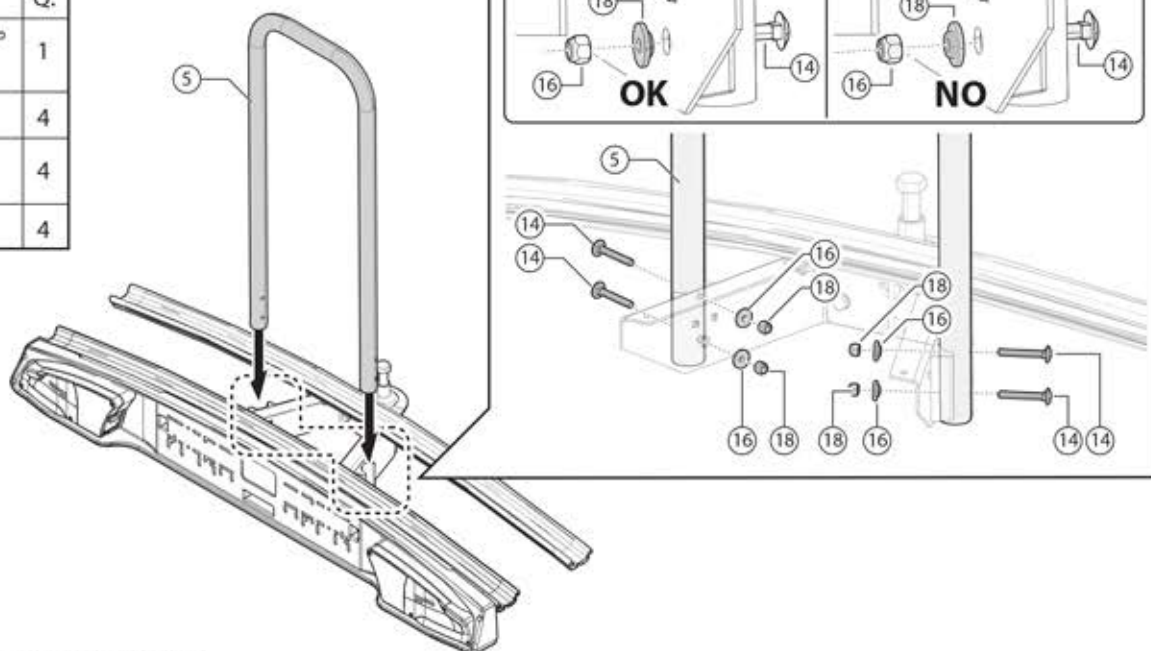

③—TYPE S / TYPE K / TYPE Q

N.		Q.
5		1
18		4
14		4
16		4



④—TYPE S / TYPE K / TYPE Q

N.		Q.
7		2
8		4

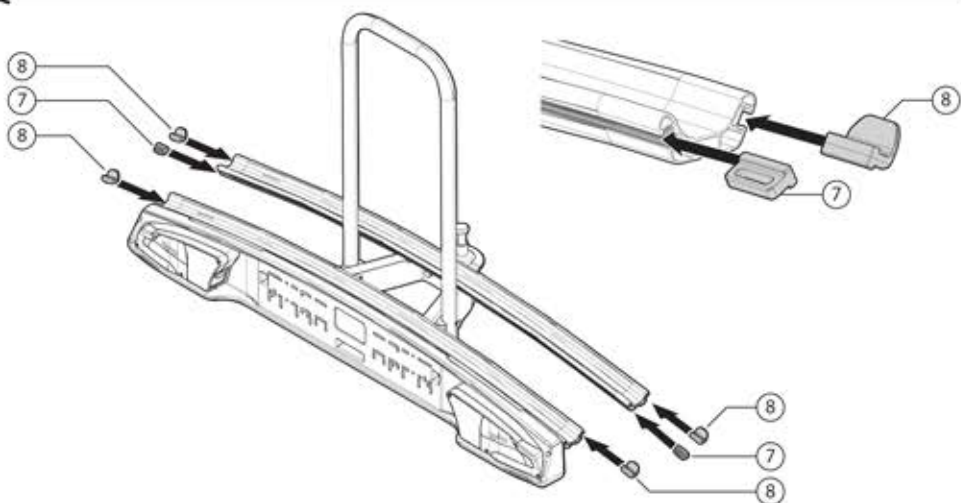

⑤—TYPE S / TYPE K / TYPE Q

N.		Q.
2		4

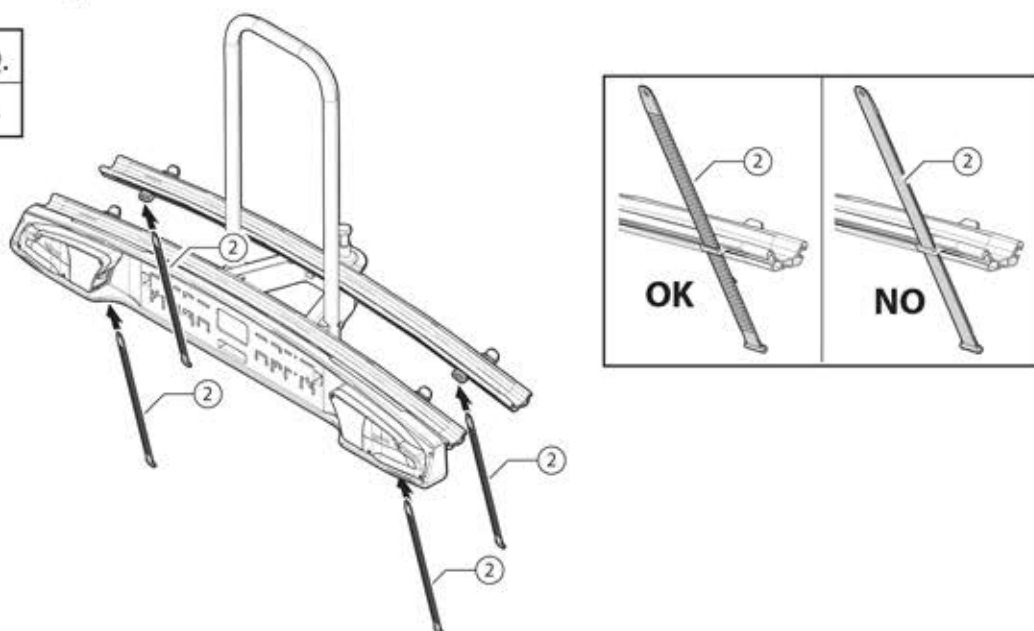

⑥—TYPE S / TYPE K / TYPE Q

N.		Q.
9		4

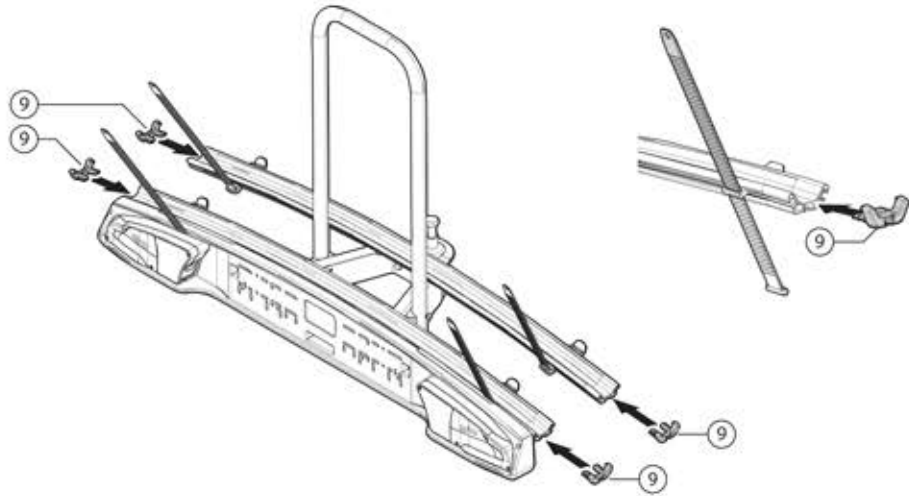

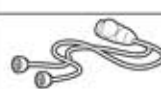

⑦—TYPE S / TYPE K / TYPE Q

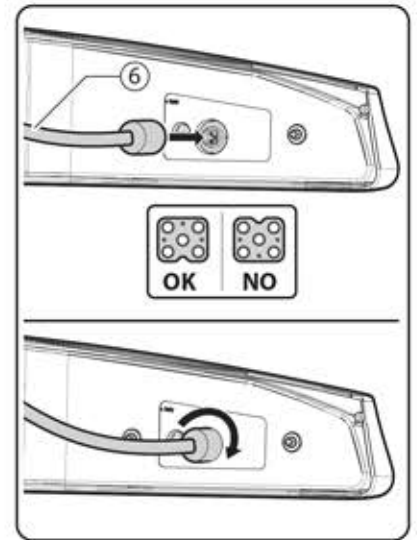
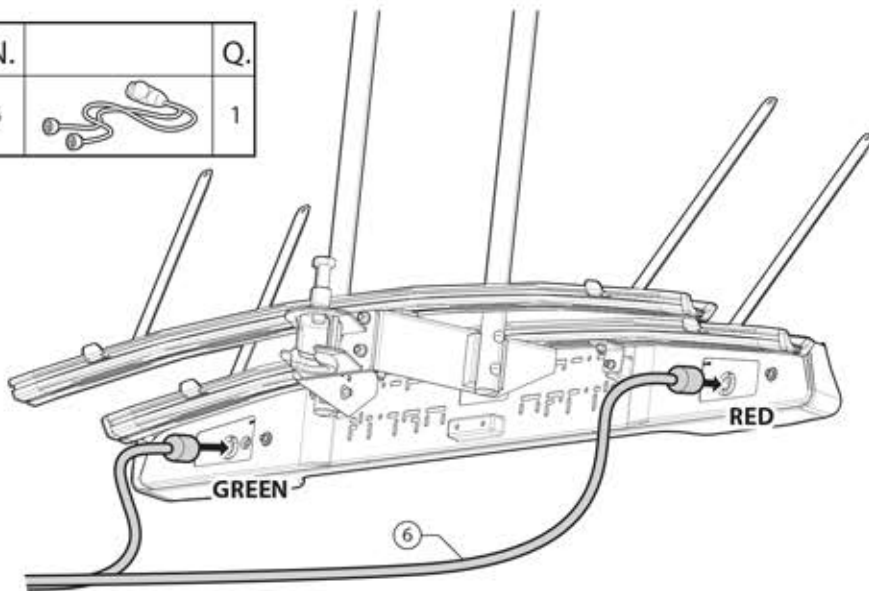
N.		Q.
6		1



⑧—TYPE S / TYPE K / TYPE Q

N.		Q.
4		2
19		2

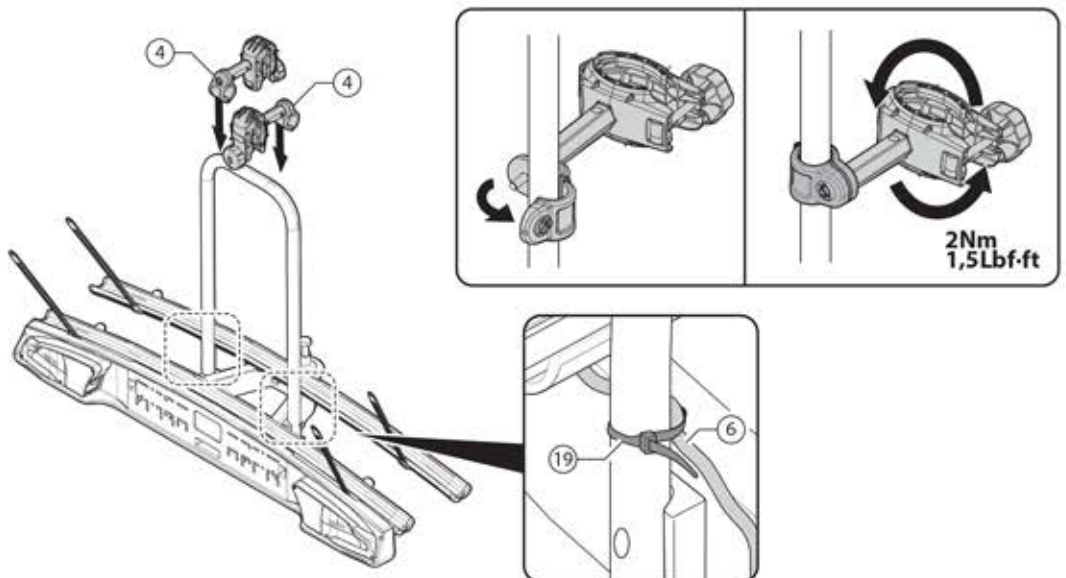

TYPE Q

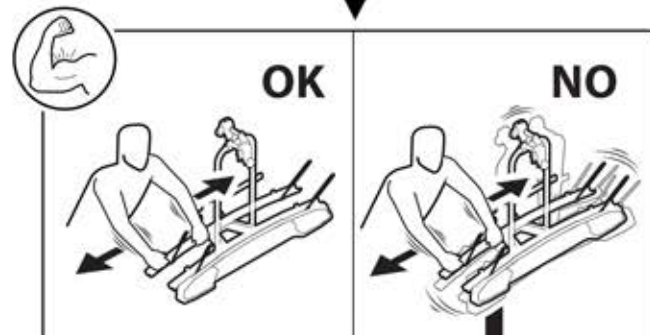
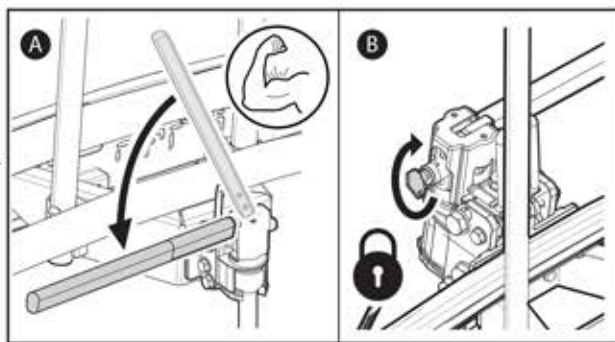
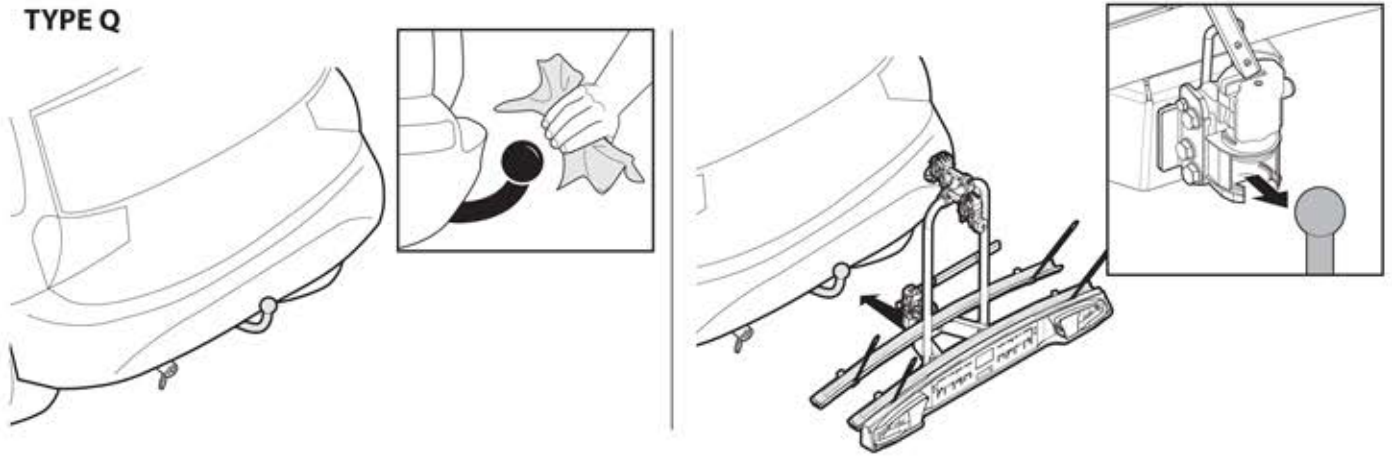

pag.13

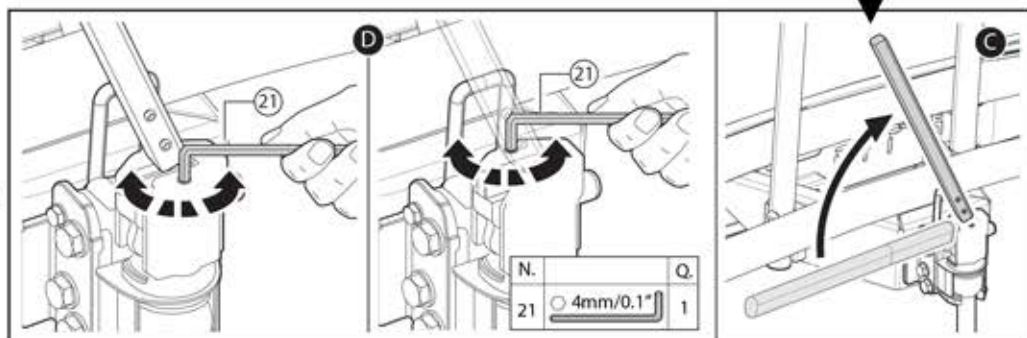

TYPE Q

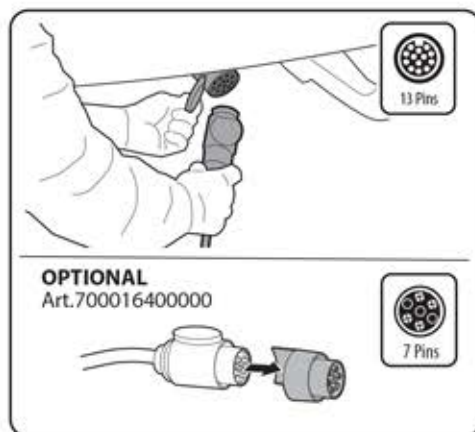
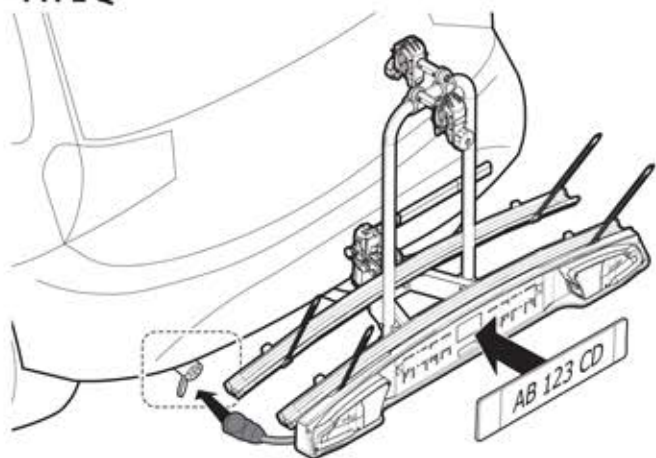

TYPE S / TYPE K

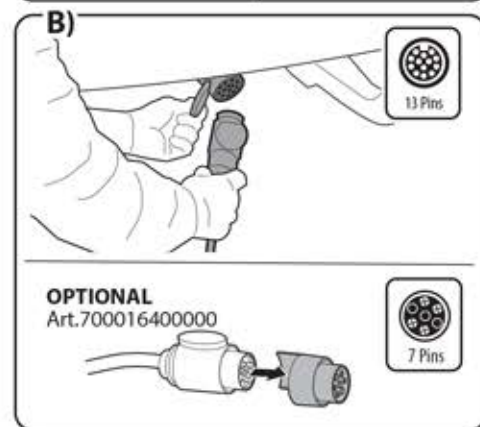
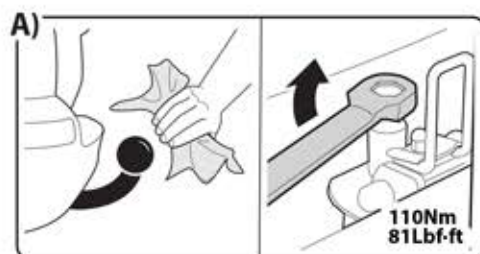
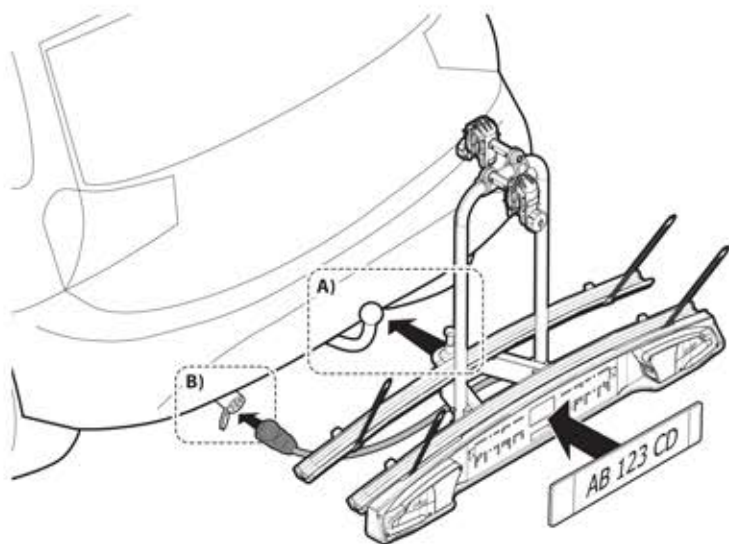

10 TYPE S / TYPE K / TYPE Q

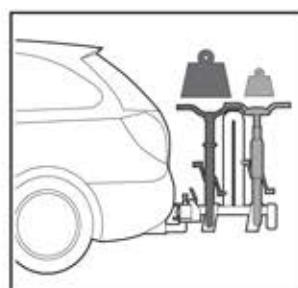
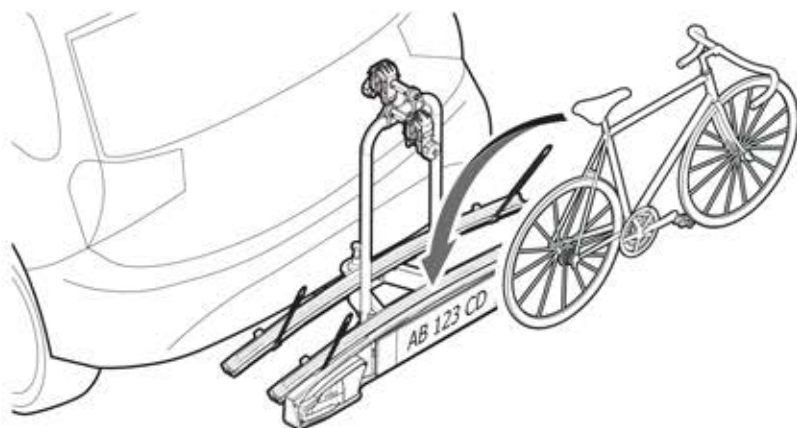

● MIN Ø30 mm / 1,2"
MAX Ø50 mm / 2"
■ MIN 30x60 mm / 1,2"x2,4"
▼ MAX 50x70 mm / 2"x2,7"



MIN 22"
MAX 29"



MAX 40mm / 1.6"



MAX 1260mm / 49.6"

11—TYPE S / TYPE K / TYPE Q

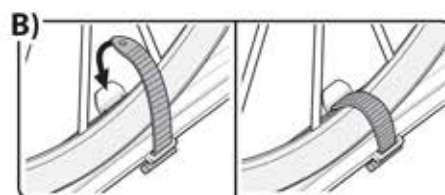
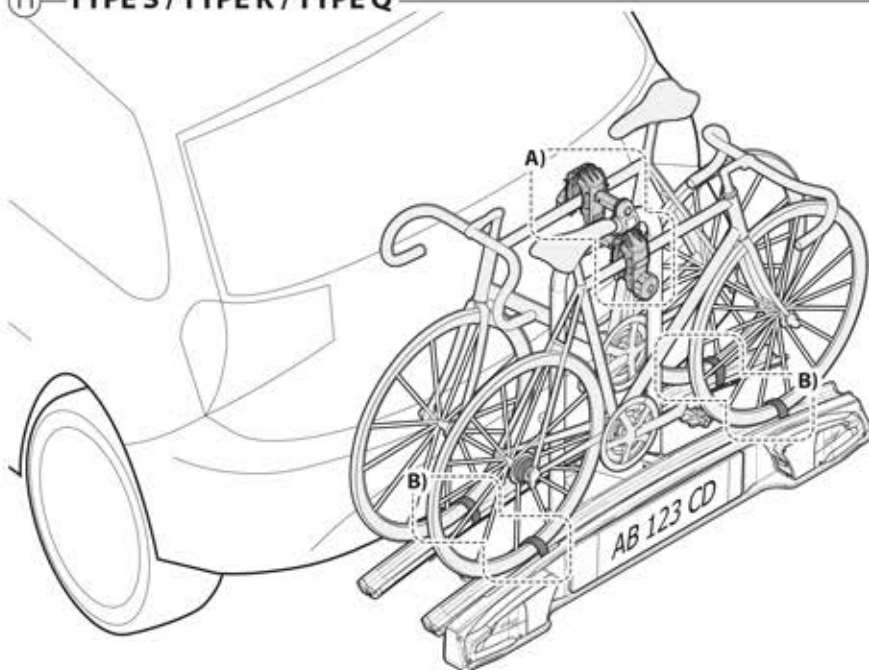

12—TYPE S / TYPE K / TYPE Q





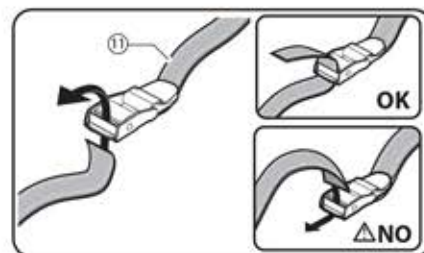
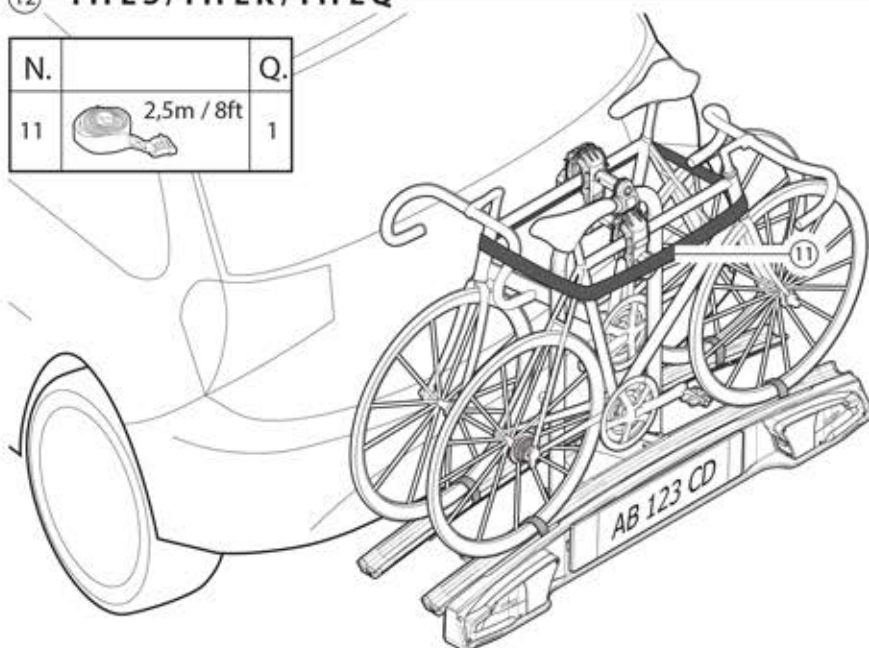

N.	Q.
11	1

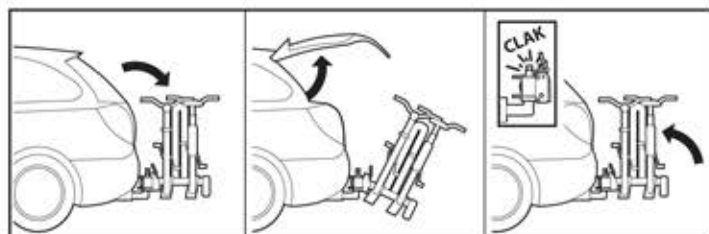
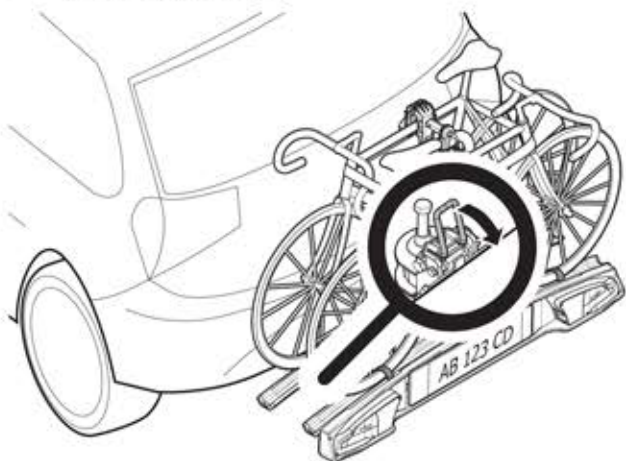



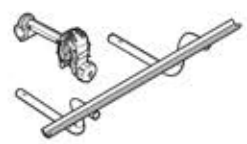



2,5m / 8ft



TYPE K / TYPE Q



OPTIONAL		
BRACCETTO CORTO  Art.000103900000	POMELLO ANTIFURTO  Art.000026400000	KIT 2+1  Art.000117800000
EVIDENCE MIRROR  Art.000083100000	RAMPA  Art.000082100000	ADATTATORE 7 PIN  Art.700016400000

MAX  94/20/CE STANDARD	 Type S	 Type K	 Type Q	Standard x2  MAX 15kg / 33lb	E-bike x1  MAX 30kg - 66lb	 Car Manual
	OR			 MAX 15kg / 33lb	 MAX 30kg - 66lb	
50 kg - 110,2lb	9,6 kg / 21lb	10,6 kg / 23.3lb	11,7 kg / 25.8lb	30kg / 66lb		
60 kg - 132,3lb				30kg / 66lb		
70 kg - 154,3lb				30kg / 66lb		
80 kg - 176,4lb				30kg / 66lb		
>80 kg - 176,4lb				30kg / 66lb		

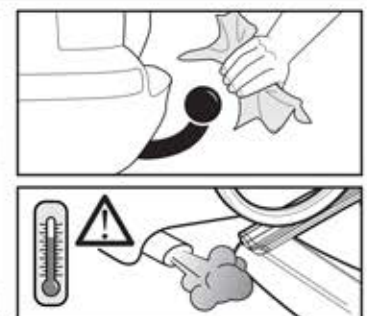
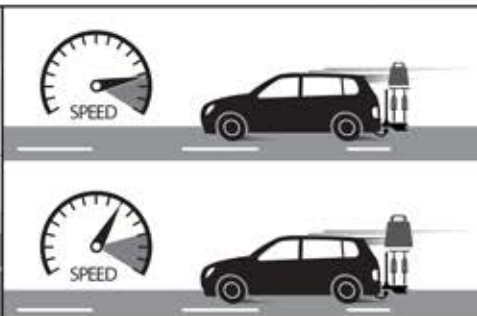
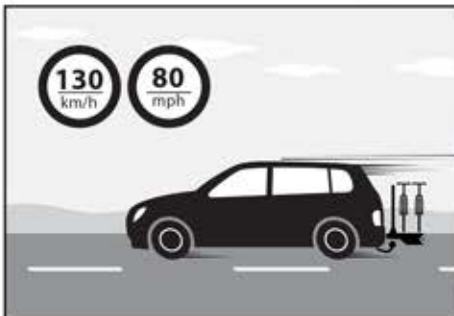
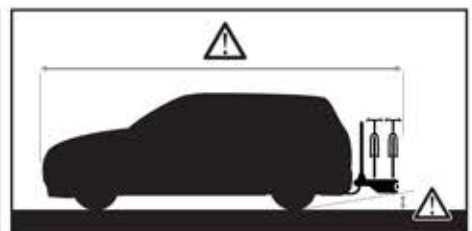
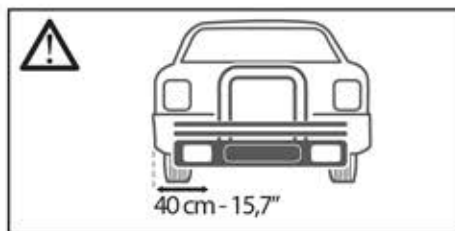

F.lli Menabò S.r.l.
Via 8 Marzo, 3
42025 Cavriago (RE) Italy
Tel. +39-0522/942840
Fax. +39-0522/942948
e-mail: info@flli-menabo.it
www.flli-menabo.it

Cod.Istr.	Data	Creato da	Approvato da
S00034100000	29/10/2019	NP	EL